



DIG-CCCV-15W

Programmable Digital Constant Current Constant Voltage Power Supply with Status Relay



DIG-CCCV-15W product photography

Feature summary

- Ultra Long Life Design, without electrolytic capacitors
- Digital Programmable
- Output Voltage: 10V - 60V
- Up to 1.2 A output current
- Up to 15 W output power
- Status Relay (Programmable)
- Output Disable & Power Off
- Resilient Design

Product description

The DIG-CCCV-15W power supply is a member of **Ultra-Long-Life** Family, avoiding failure-prone electrolytic capacitors. It features a wide output voltage range from 10 V to 60 V with output currents of up to 1.2 A at max. 15 W output power.

Output currents and voltages can be programmed by setting the hardware pins or by software. It offers an internal and external blink-mode.

The device is resilient to typical operating failures: Input reverse polarity, output short circuit, open circuit, moderate input transients and moderate output transients.

The device offers solid output current stability over the complete input voltage range. The device may be operated at ambient temperatures between -40°C and 50°C.

Specification overview

Description	Value
Input	
Input Voltage	230 V _{ac}
Input Frequency	49 - 61 Hz
Output	
Voltage (min)	10 V
Voltage (max)	60 V
Current (max)	1.2 A
Power (max)	15 W
Protection	
Input Fuse	yes
Short circuit protection	yes
Input Overvoltage suppressor	MOV
Overvoltage suppressor	TVS
Mechanical	
Dimensions (mm)	53.5x90x58

Ordering information

Ordercode	Description
	Refer to page 3

Engineering standards

Applied engineering standards	
IEC 61558-2-6	IEC 62368-1
IEC 61010-1	
IEC 61558-2-6	





1 Functional description

1.1 Overview (Reproduced)

The DIG-CCCV-15W power supply is a member of **Ultra-Long-Life** Family, avoiding failure prone electrolytic capacitors. It features a wide output voltage range from 10 V to 60 V with output currents of up to 1.2 A at max. 15 W output power.

Output currents and voltages can be programmed by setting the hardware pins or by software. It offers an internal and external blinkmode.

The device is resilient to typical operating failures: Input reverse polarity, output short circuit, open circuit, moderate input transients and moderate output transients.

The device offers solid output current stability over the complete input voltage range. The device may be operated at ambient temperatures between -40°C and 50°C.

1.2 Ultra Long Life Device

This device utilizes Digital Power Systems Ultra Long Life Series. The technology has demonstrated in lifetime test over 70 years of continuous operation in accelerated lifetime tests.

1.3 Blinking

The DIG-CCCV-15W blink pattern can be programmed. The blink pattern can be activated, by wiring T to G. Initially, the output is off. After typically 10 seconds, the blink pattern starts. By default the output blink pattern is configured to 0.2 s on and 0.8 s off, resulting in a blink period of 1 second. If offtimes longer than 10 seconds are required, and the P pin should not be used, the blinking can be deactivated: The on- and offtime in the programming interface must be set to zero.

1.4 Protections

The following output protections are in place:

- **Input Fuse:** An input fuse prevent fire on failure.
- **Short circuit proof:** The output of the converter can be shortcircuited without problems for infinite time.
- **Open circuit proof** The output may be operated in open circuit for infinite time.
- **Input TVS diode** The converter features an input TVS diode for protection.
- **Output TVS diode** The converter features an output TVS diode for protection.
- **Galvanic isolation** The mains voltage is isolated from the output voltage.





DIG-CCCV-15W

Programmable Digital Constant Current Constant Voltage
Power Supply with Status Relay

1.5 Default Configurations

The default configurations are listed on the subsequent table.

Pin H0	Pin H1	Voltage	Current
Variable Voltage Configuration			
Ordernumber DIG-CCCV-15W-VAR			
0	0	12 V	1.2 A
0	1	24 V	0.625 A
1	0	48 V	0.313 A
1	1	60 V	0.25 A
12 V Configuration			
Ordernumber DIG-CCCV-15W-12V			
0	0	12 V	0.25 A
0	1	12 V	0.5 A
1	0	12 V	0.75 A
1	1	12 V	1.2 A
24 V Configuration			
Ordernumber DIG-CCCV-15W-24V			
0	0	24 V	0.1 A
0	1	24 V	0.2 A
1	0	24 V	0.4 A
1	1	24 V	0.625 A
48 V Configuration			
Ordernumber DIG-CCCV-15W-48V			
0	0	48 V	0.1 A
0	1	48 V	0.2 A
1	0	48 V	0.3 A
1	1	48 V	0.312 A
60 V Configuration			
Ordernumber DIG-CCCV-15W-60V			
0	0	60 V	0.05 A
0	1	60 V	0.1 A
1	0	60 V	0.2 A
1	1	60 V	0.25 A
Customer specific			
Contact Digital Power Systems for Customer Specific configuration. A small (MOQ) Minimum Order Quantity may apply.			



2 Pinout

The pinout of the converter is depicted in Figure 1.

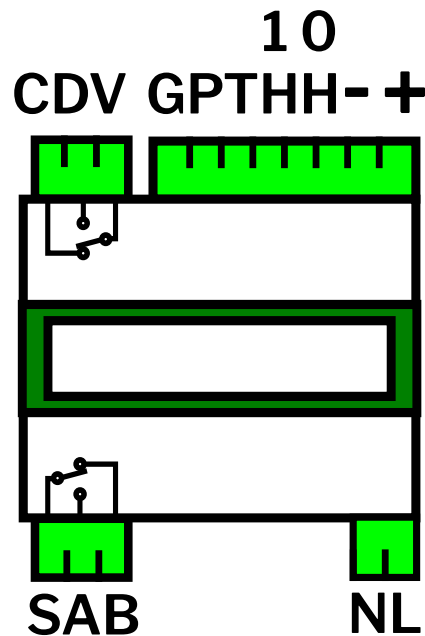

Figure 1: Power Supply Connection Diagram

Pin	Functional description
Input	
N	Grid Neutral
L	Grid Conductor
Output	
-	LED Negativ Connection - not equal to ground
+	LED Possitive Connection
Relay	
V,S	Relay-Midpoint
C,B	Normally Disconnted to Relay-Mindpoint
A,D	Normally Connected to Relay-Mindpoint
Control Inputs	
G	GND of the circuit (not eqal to LED Midpoint)
P	Power: The output switch is turned off, when connected between GND and Power is established. If turned of, the relay actuates.
T	Turnoff: The output switch is turned off, when connected between GND and Power is established. If turned of, the relay is not turned off. If T is kept lower longer than 10 seconds, the automatic blink patern starts.
H	Preconfiguration. Binary input, H1 is the most significant bit, while H0 is the least significant bit. In normal mode, option 4 is activated.





DIG-CCCV-15W

Programmable Digital Constant Current Constant Voltage
Power Supply with Status Relay

3 Specification

The specification is shown in the following table. If not otherwise specified the following parameters have been used: $T_{amb}=25^{\circ}\text{C}$.

	Min	Typ	Max	Unit
Primärseite Primary Side				
Eingangsspannung Input Voltage	200	230	250	$V_{ac,rms}$
Leistungsfaktor Power factor	0	0.4	1	
Anzahl AC Phasen Number of AC Phases	1	1	1	
Eingangssicherung Artikelnummer Input Fuse Partnumber	2410-0750TS			
Sekundärseite Secondary Side				
Ausgangsspannung Output Voltage	10		60	V_{dc}
Ausgangsstrombereich Output Current Range	0.1		1.2	A_{dc}
Ausgangsstromtoleranz Output Current tolerance	- 0.02		0.02	A_{dc}
Kontinuierliche Ausgangsleistung Continous Output Power	0		15	W_{peak}
Galvanische Isolation Galvanic Isolation		500		V_{rms}
Blinkender Ausgang Blinking Output	yes, wire input T to G for $t>10s$.			
Blinken Anzeit default Blinking Ontime		0.2		s
Blinken Auszeit default Blinking Offtime		0.8		s
Statusmeldung Reporting Contact				
Art des Meldekontakts Typ of Reporting Contact	Relay			
Anzahl Relaykontakte Number of Contact	2	2	2	Pieces
Relaiskonfiguration Relay Configuration	Double Pole Double Throw			
Schaltvermögen Relais Relay Switching power	230 V_{ac} 2A 60W			





DIG-CCCV-15W

Programmable Digital Constant Current Constant Voltage
Power Supply with Status Relay

	Min	Typ	Max	Unit
Betriebsmodi Operating mode				
Betriebsstrategie Control Strategy	Constant Current Constant Voltage (CCCV)			
Programmierschnittschnelle Programming Interface	MCU Tracer (PC Software)			
Programmierwerkzeug Programming Tool	Isolated USB/UART Adapter			
Externer Kontakte External Contact				
Versorgungsspannung des Mikrocontroller Supply voltage of the microcontroller		3.3		V _{DD}
Spannungslevel Niedrig Voltage Level Low			0.3 V _{DD}	V
Spannungslevel Hoch Voltage Level High	0.7 V _{DD}			V
Maximaler Spannungslevel Ein Max. Voltage Level			5	V
Gehäuse Case				
Montageform Mounting Type	Din RAIL			
Breiteinheiten Mounting Units	3 Units			
Montagehöhe Mounting Height	Fuse construction height			
Sicherheitsfeatures Safety Features				
Kurzschlusschutz Short circuit protection	available			
Leerlaufschutz Open circuit protection	available			
Schutzlackierung Unterseite Conformal coating bottom side	available			
Transientenschutz Transient protection	Metal-oxide varistor			
Technische Merkmale Technical Characteristics				
Temperaturbereich Temperature Range	-40		50	°C
Elektrolytkondensatoren Electrolytic Capacitors	No electrolytic capacitors			





DIG-CCCV-15W

Programmable Digital Constant Current Constant Voltage
Power Supply with Status Relay

	Min	Typ	Max	Unit
Steckverbinder				
Connectors				
Wechselstrom Steckverbinder AC Input Connector		2 poles, pitch 5.08mm		
Relais Steckverbinder Relay Connector		3 poles, pitch 5.08mm		
Relais Steckverbinder/Rückfalloption Relay Connector Fallback		3 poles, pitch 5.08mm		
LED/Daten Steckverbinder LED/Data Connector		7 poles, pitch 2.5mm		





4 Programming

The programming is done over the UART interface. A UART interface may be used for programming **and** monitoring of the UART interface.

4.1 Safety - Read before

Programming the device requires physically opening the device's case. Therefore, the warranty is void. Opening the device may lead to electric shock, injuries, or death. Only electrical personnel are allowed to program the device. For the programming, only DPS USB-UART Converters may be used. The UART Converter must be isolated. Careful attention must be given to match the UART converter polarity.

4.2 Requirements

For the programming of DIG-CCCV-15W, the following components are required:

- Isolated USB UART Cable
- Isolation Transformer
- Personal Computer
- MCU Tracer software

4.3 MCU Tracer Setup

When the MCU Tracer is installed, click on it to open. The mcu tracer requires configuration, the setup must be done using the following configuration:

Paramter	Setting
Cable	
Type of Cable	JST-PH-4
Cable for Programming	Standard (non-crossover)
UART Configuration	
Baud-Rate	115200 Baud
Paritiy	none
Data-Bits	8
Stop-Bits	1

The mcu tracer can be found under the following domain:

https://gitlab.com/greenscreenflicker/mcu_tracer





DIG-CCCV-15W

*Programmable Digital Constant Current Constant Voltage
Power Supply with Status Relay*

5 Measurements

5.1 Measurement Conditions

All measurements were made at room temperature.



5.2 DIG-CCCV-15W

5.2.1 Switch-on behavior

The switch-on behavior is depicted in Figure 2.

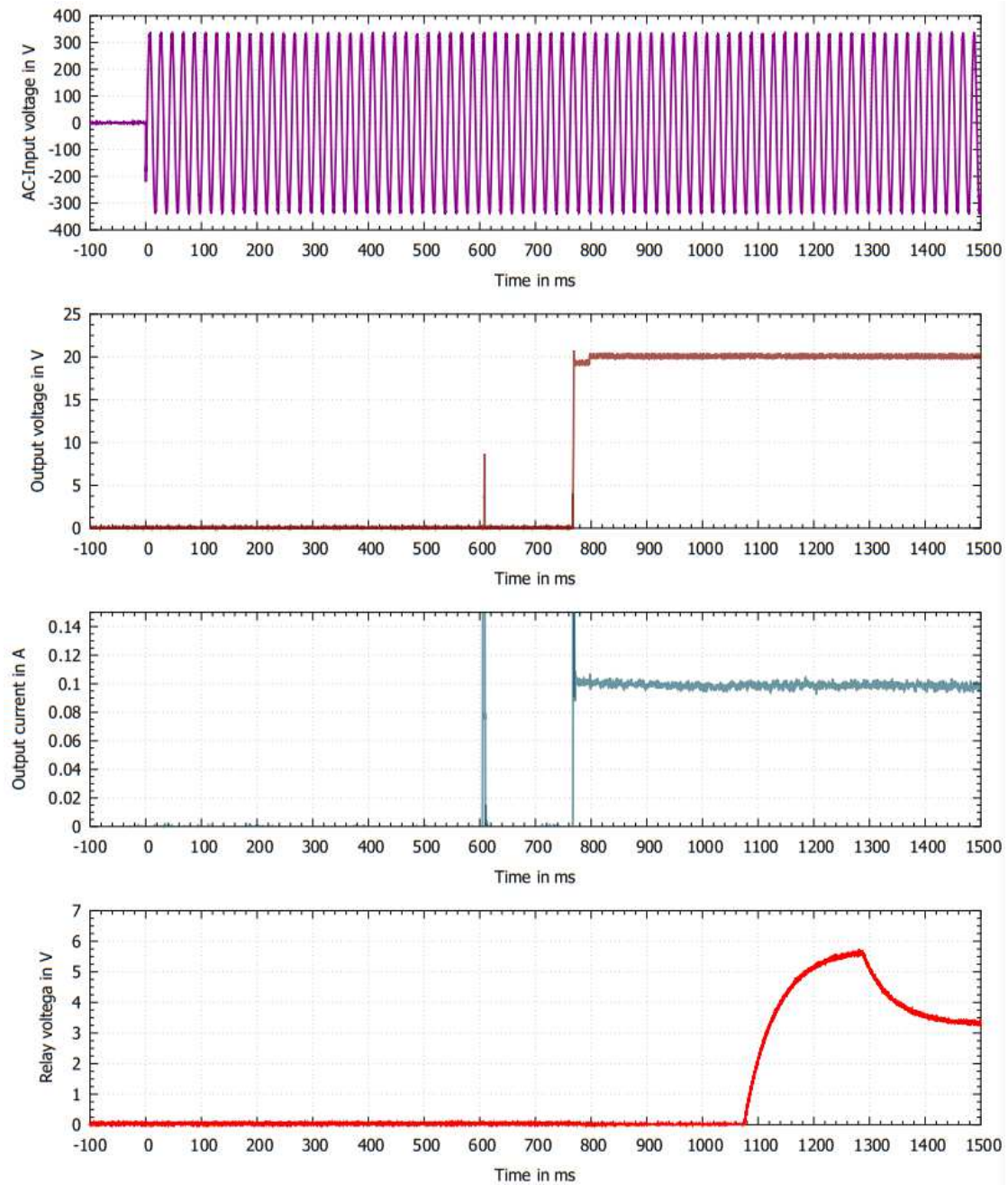

Figure 2: Switch on behavior for 20V output voltage and 0.1A output current



5.2.2 Switch-off behavior

The switch-off behavior is depicted in Figure 3.

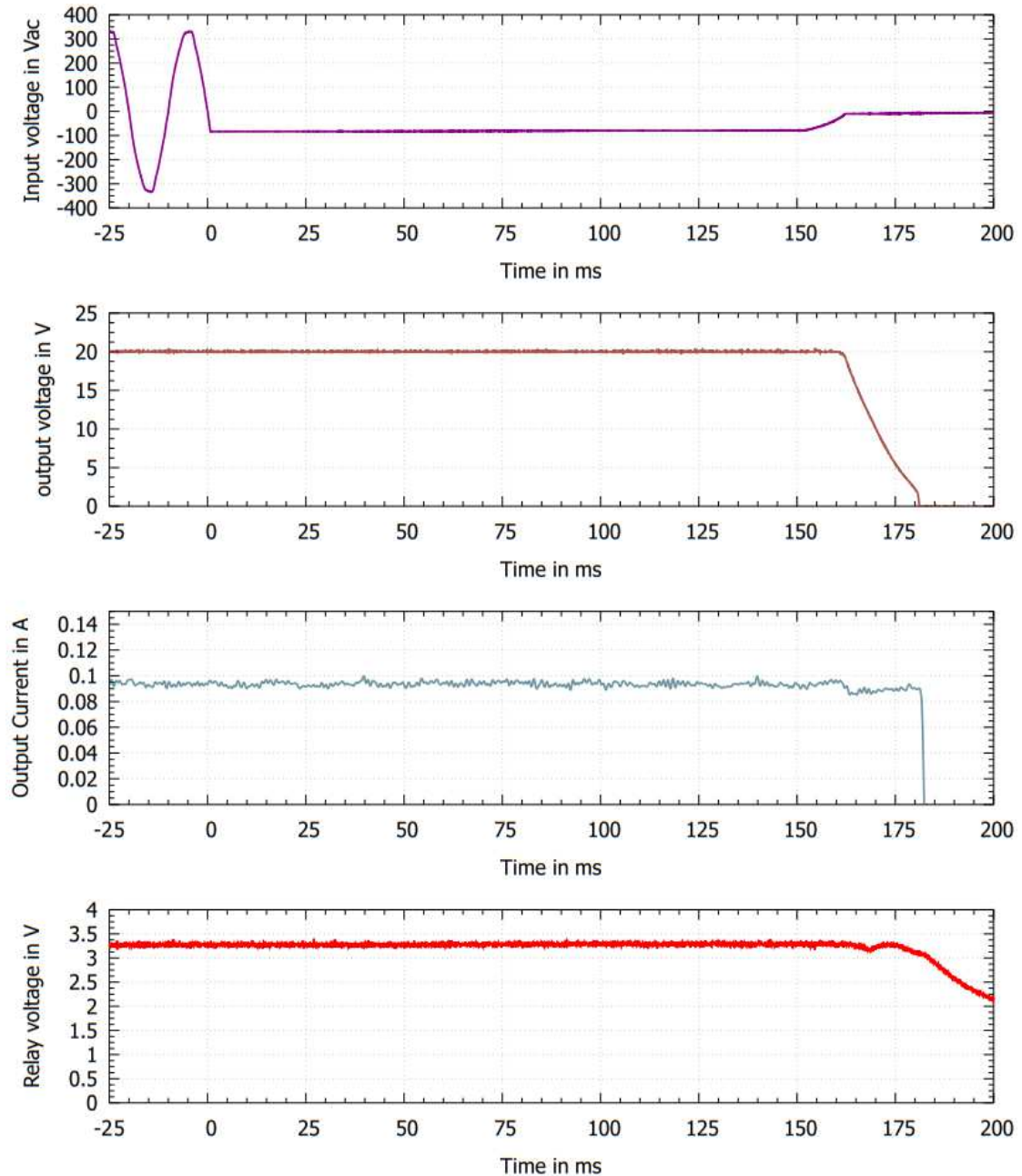

Figure 3: Switch off behavior for 20V output voltage and 0.1A output current



5.2.3 Load-on behavior

The load is turned on at $t=0$ sec. The corresponding behaviour is depicted in Figure 4.

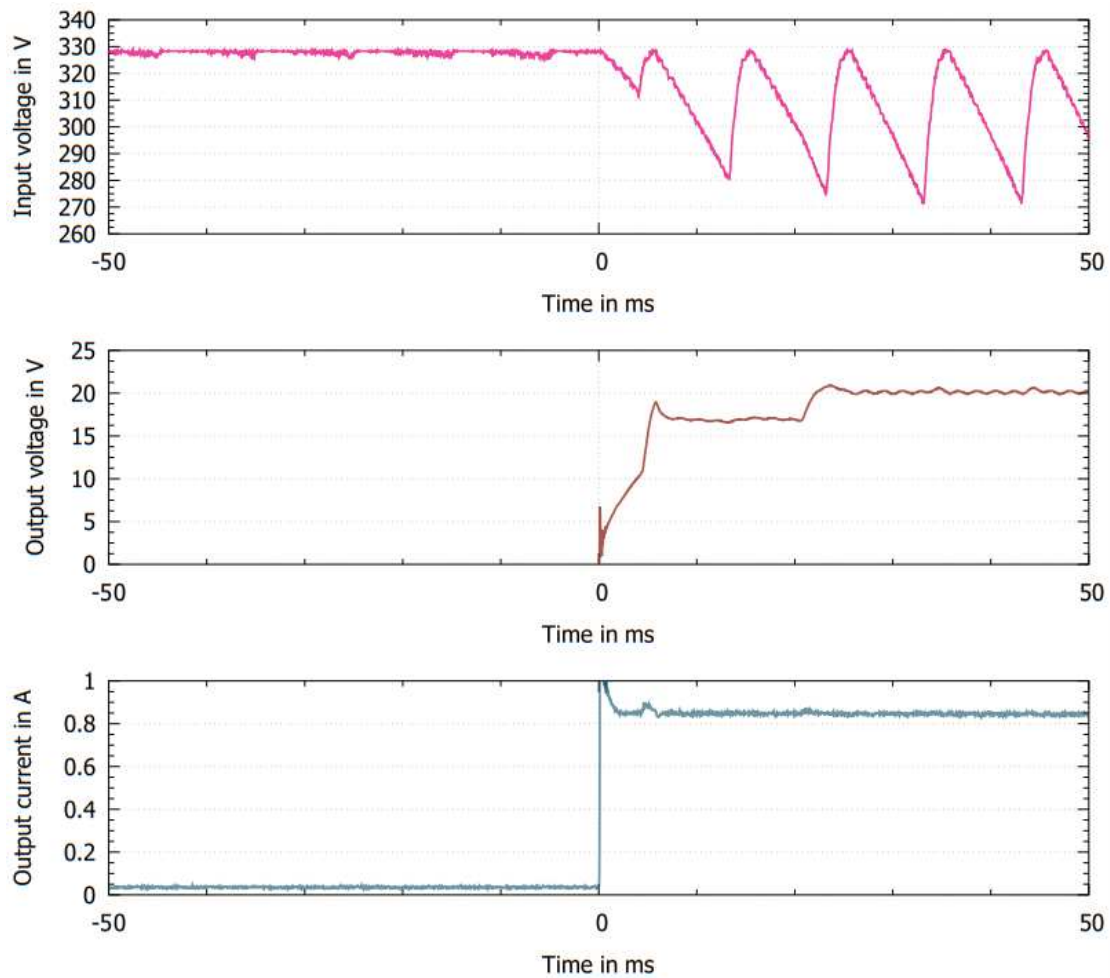

Figure 4: Load on behavior for 20V output voltage and 0.84A output current



5.2.4 Load-off behavior

The load-off behavior is depicted in Figure 5.

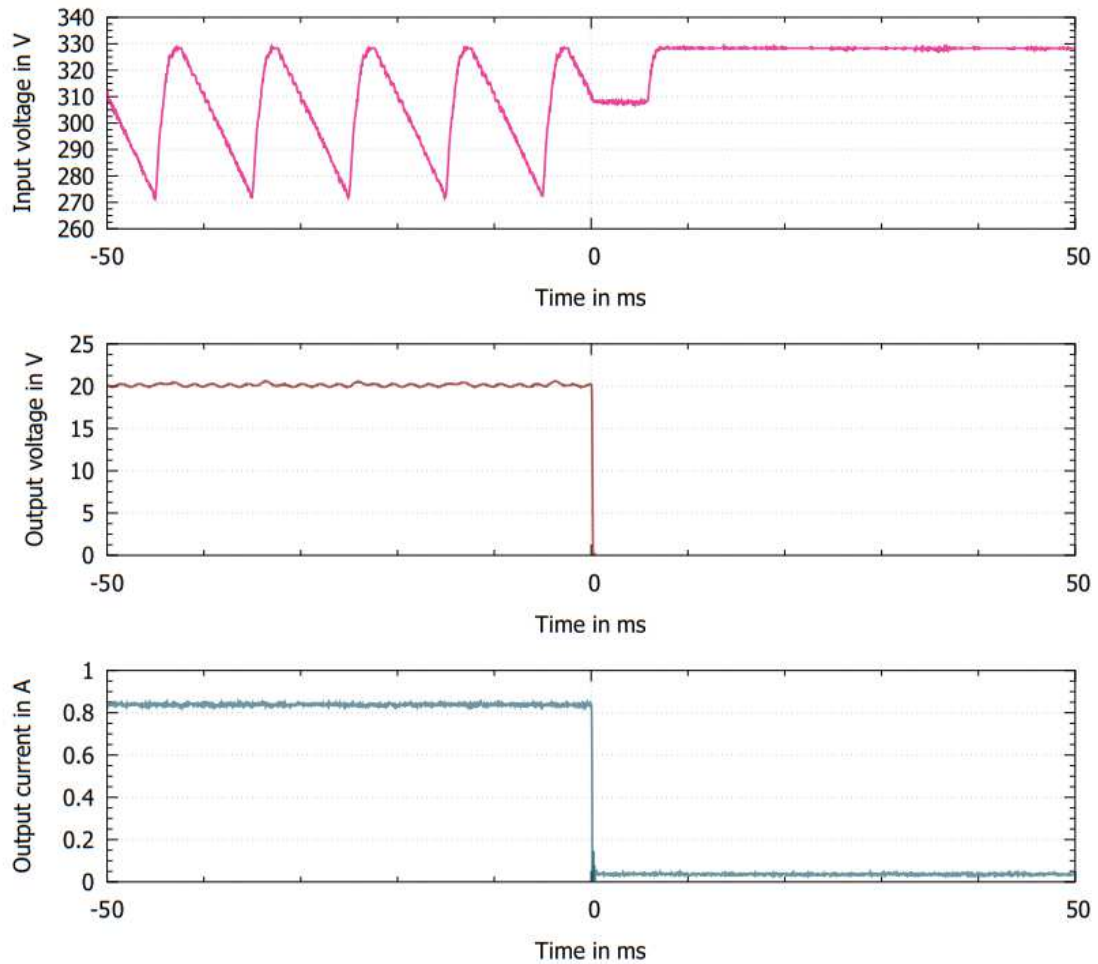

Figure 5: Load off behavior for 20V output voltage and 0.84A output current



5.2.5 Full-Load behavior at 10V and 1.2A

The full-Load behavior at 10V and 1.2A is depicted in Figure 6.

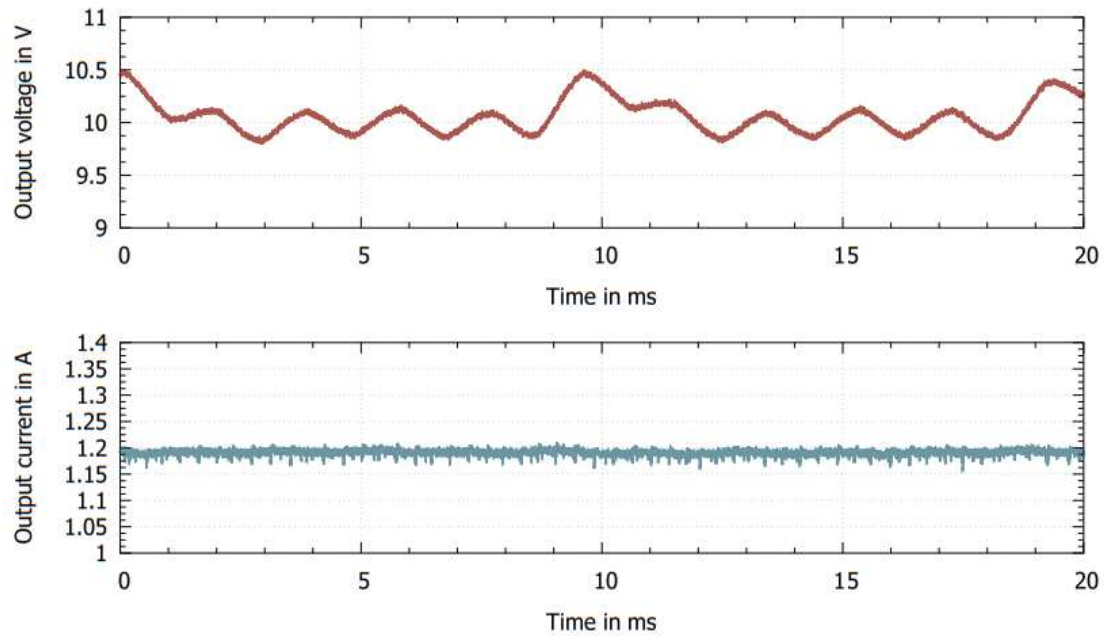

Figure 6: Full-Load behavior at 10V output voltage and 1.2A output current



5.2.6 Full-Load behavior at 60V and 0.1A

The full-Load behavior at 60V and 0.1A is depicted in Figure 7.

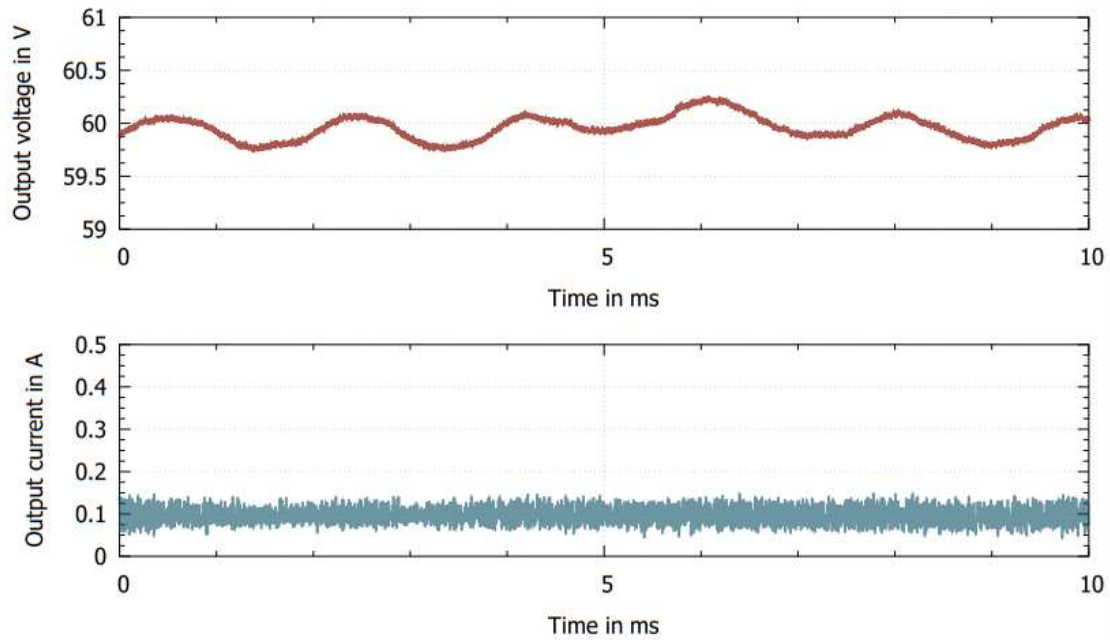

Figure 7: Full-Load behavior at 60V output voltage and 0.1A output current



5.2.7 Efficiency

The efficiency is depicted in Figure 8.

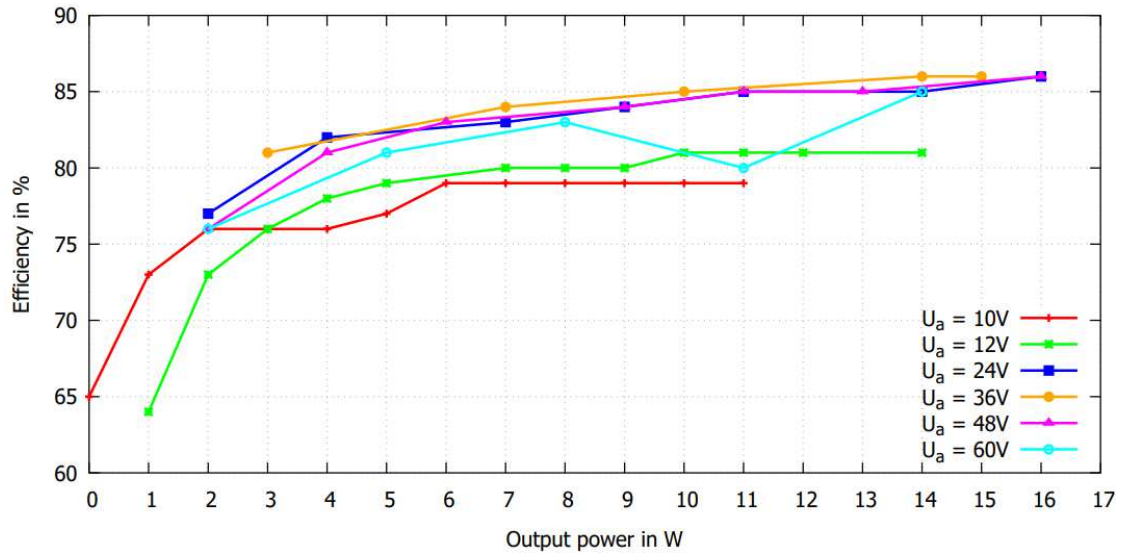

Figure 8: Efficiency as a function of electrical power

5.2.8 Power factor

The power factor is depicted in Figure 9.

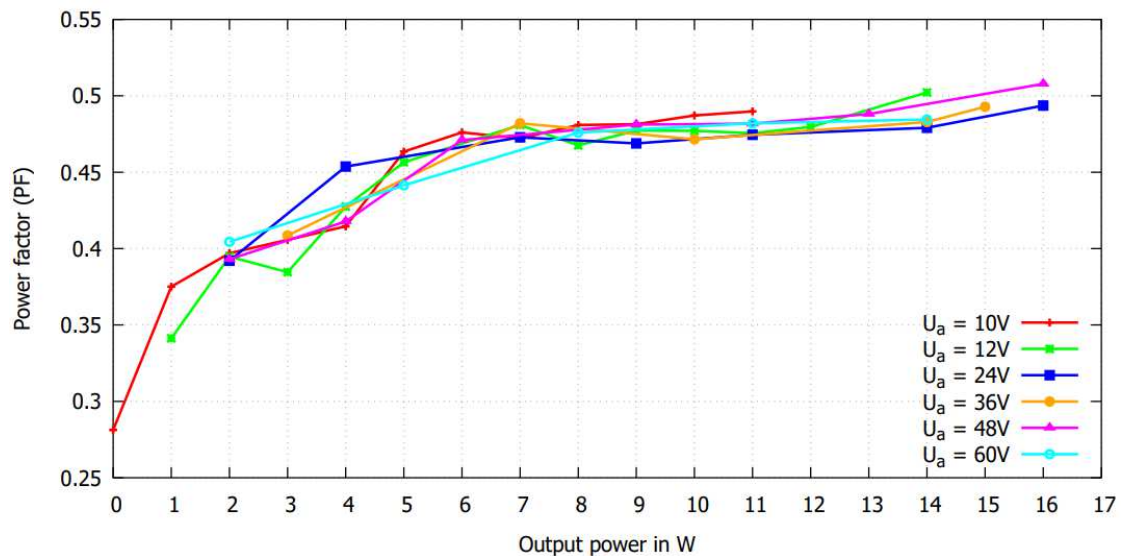

Figure 9: Power factor as a function of electrical power



5.2.9 Peak-to-peak output current

The peak-to-peak current is depicted in Figure 10.

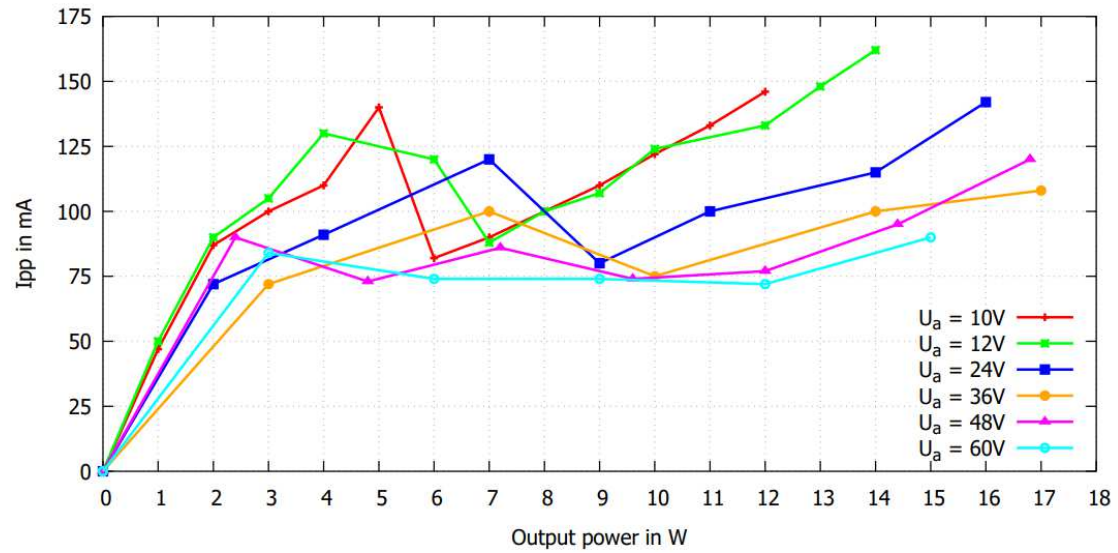

Figure 10: Peak-to-peak current as a function of electrical power



6 EMC Measurements

6.1 DIG-CCCV-15W

The conducted Input emissions are depicted in Figure 11.

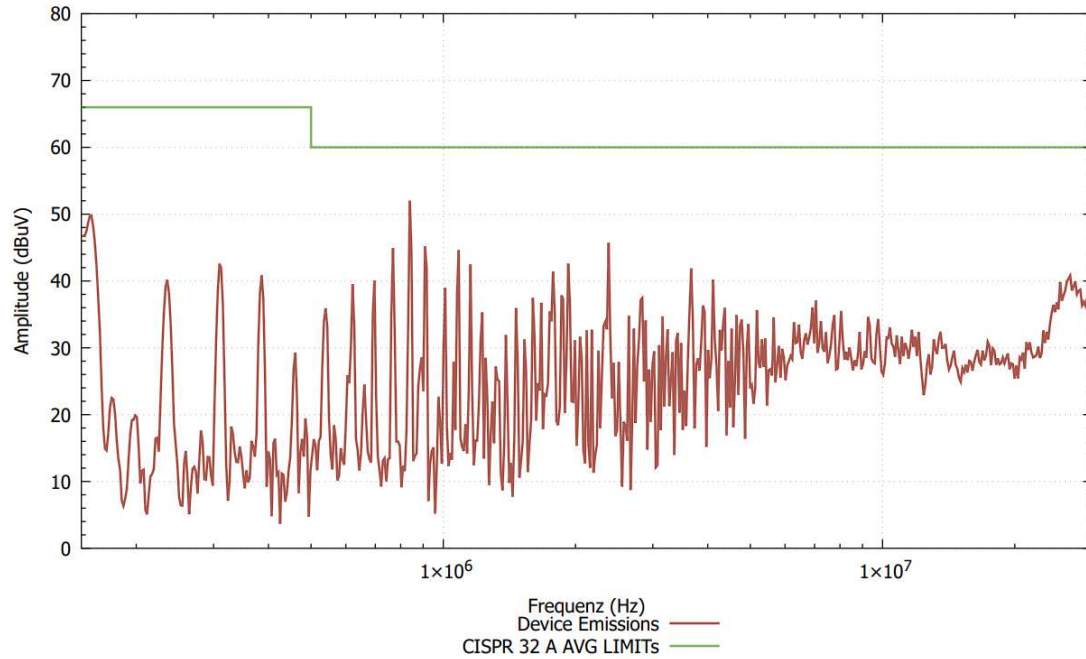

Figure 11: Conducted Input emissions



The conducted Output emissions are depicted in Figure 12.

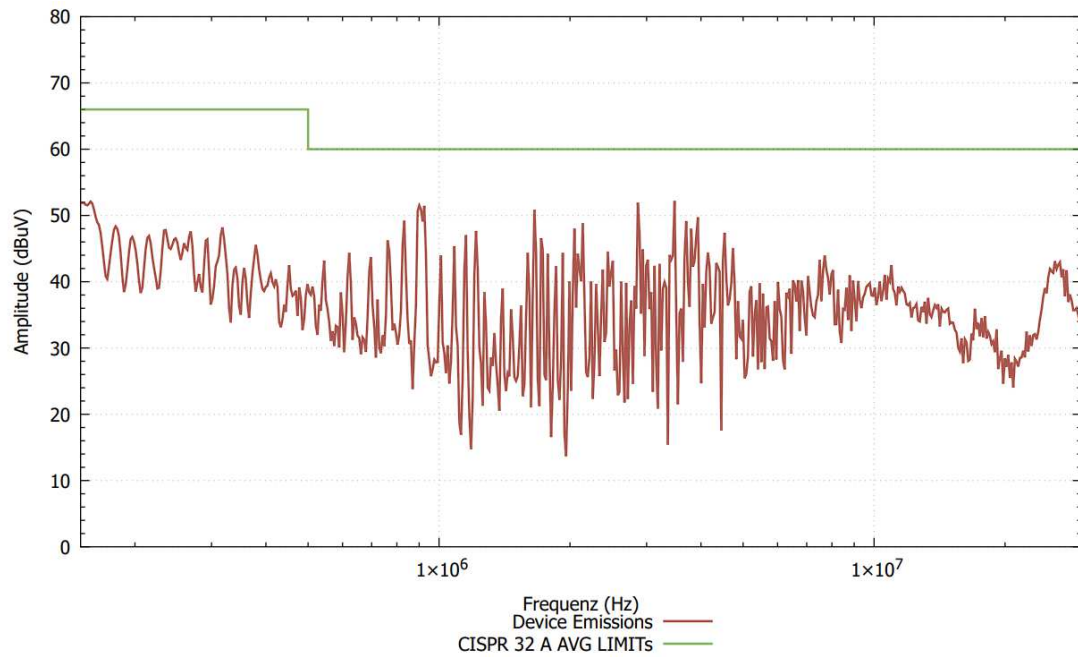

Figure 12: Conducted Output emissions



7 Case

The DIG-CCCV-15W case drawing is shown in Figure 13.

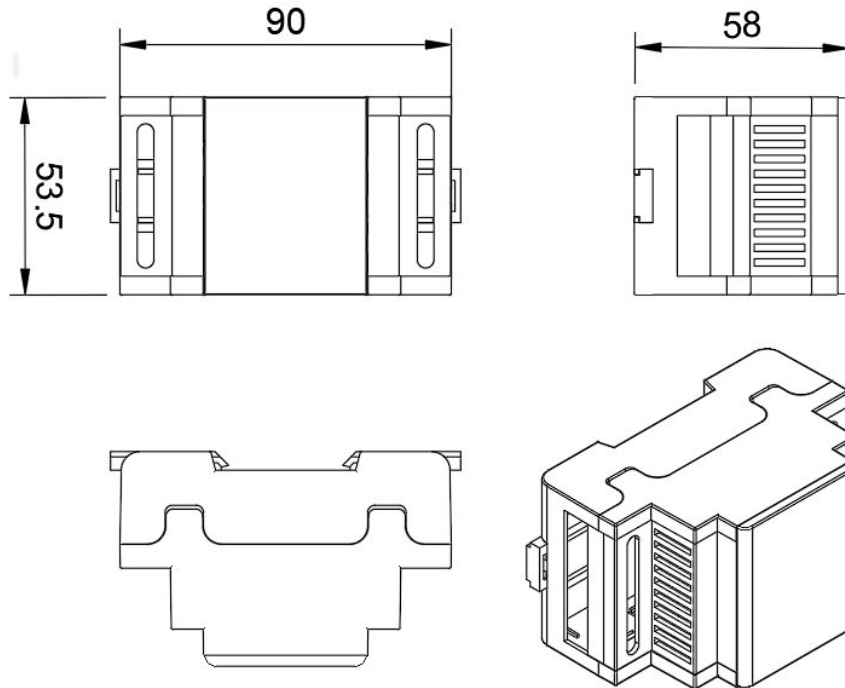

Figure 13: DIG-CCCV-15W Product case.

8 Product label

The Label for the DIG-CCCV-15W is depicted in the following Figure 14.

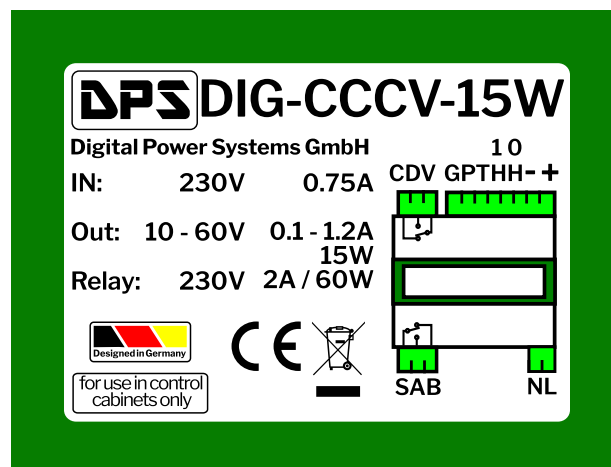

Figure 14: The product label of the DIG-CCCV-15W.





DIG-CCCV-15W

Programmable Digital Constant Current Constant Voltage
Power Supply with Status Relay

9 Document

9.1 Datasheet Quality

Digital Power Systems aims for the highest datasheet quality. We value your feedback to improve this document. Please email:

`datasheet (ät) digitalpowersystems (döt) eu`

9.2 Revision History

The revision history is depicted in the following table.

Date	Changes in Revision
28.09.2023	Initial release
24.10.2023	Details on blinking mode added.
18.01.2023	Added product programming information - updated product picture
26.02.2023	Clarification of input PINs in pin description

9.3 Contact Information

This is a product of the Digital Power Systems GmbH (DPS).

Digital Power Systems GmbH
Haid- und Neu Str. 7
76131 Karlsruhe, Germany

Visit our website: www.digitalpowersystems.eu

